

Orchestrating a brighter world

**NEC**

Professional projectors of high performance and brighter LCD models that are lightweight and compact  
Professional Installation Projector

**PA803U / PA723U / PA653U**  
**PA853W / PA703W / PA903X**



# A compact projector solution for large venue applications and vertical markets boasts Ultra HD support, wider colour space, scaling, resolution and reduced maintenance

## A High-efficiency Design with High-brightness Projection and Reduced Maintenance

### The Lightest and Most Compact WUXGA Projector Over 8000 lumens (NP-PA803U)\*

A lightweight and compact WUXGA projector (NP-PA803U) of 10.2 kg, 33.23 liters\*\* and 8000 lumens brightness with NEC's unique cooling system for the LCD panel (patented) and the lamp.

\* Not including lens, according to our research as of January 2017  
\*\* Not including protruding parts

#### NEC's unique LCD cooling method

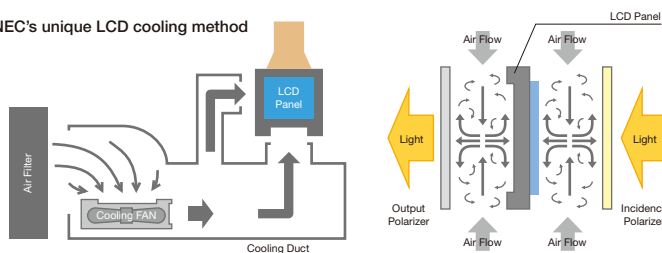

### An Energy-saving Design with Standby Power Consumption

When the on-screen menu's standby mode is set to "NORMAL", power consumption in standby mode with power management on is 0.15 W (100 – 130 V) / 0.21 W (200 – 240 V) and 0.11 W (100 – 130 V) / 0.16 W (200 – 240 V) when the LAN is off.

### Reduce Maintenance and Expenses

When Eco mode is used, lamp replacement time is extended to a maximum of 5,000 hours\*. At the same time, the maximum usage time for the filter is 10,000 hours\*\*. This virtually maintenance-free filter reduces the frequency at which cleaning is required, thereby decreasing total cost of ownership.

\* This time is not guaranteed.  
\*\* Varies by projector installation conditions.



## A High-definition Design to Meet the Era of High-resolution Content and Devices

### NEC's Unique High-definition Functionality with the 4th Generation of "SweetVision" for 4K Content

"SweetVision" newly supports 4K 60 Hz input signals and has been upgraded to support HDR10 and Rec.2020 signal inputs. It offers a high definition image by raising the contrast in the boundary parts of an image by using the "Craik-O'Brien-Cornsweet effect".

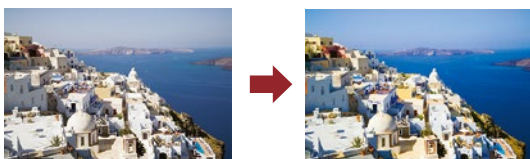

### Supports High-definition Processing of Both Digital and Analogue Inputs

10-bit high-definition signal processing is possible with all digital and analogue inputs. An image can be projected with an excellent contrast of 1024 gradations and over 1 billion colours in 4K images.

### 4K Ready

The New PA series supports HDR10 and BT.2020 signals for various 4K content (including next generation "Ultra HD Blu-ray" and "4K TV broadcasting").

## Multiple Input Terminals for HDMI and DisplayPort and Input and Output Terminals for HDBaseT

### The First Projector Available Worldwide with Built-in HDBaseT (IN/OUT) Support (NP-PA803U)\*

Simplify your installations with HDBaseT. The projector is optimized for video applications and supports uncompressed full HD digital video, audio, Ethernet, power and control signals. With only a single cable (up to 100 m) to run, infrastructure and labour costs are reduced, installations are significantly easier, and there is no cable clutter to manage. With uncompressed HD video support, images have never been more stunning. What's more, control signals are contained in the same cable.

\* Passed the examination of the testing agencies approved by the HDBaseT Alliance as of December 15th, 2016. Website of HDBaseT Alliance: <http://hdbaset.org/advanced-search>

### A Wide Selection of Digital Inputs such as HDMI and DisplayPort

Among the PA Series' wide selection of inputs are dual HDMI with HDCP and DisplayPort with HDCP for connecting to high-definition sources such as Blu-ray players, cable boxes, satellite receivers and personal computers.

#### Terminals

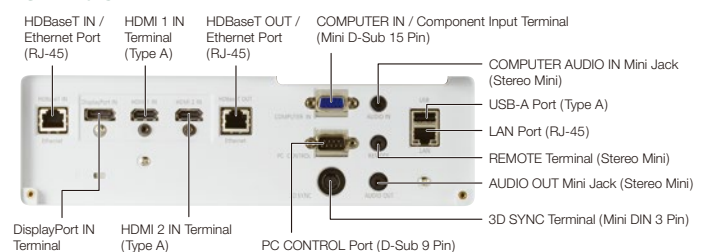

# Excellent Ease of Installation and Functionality in Various Uses and Applications

## Multi-screen Function

Multi-display capabilities and tiling technologies are integrated. The projector is also equipped with multiple digital input and HDBaseT output terminals that can connect multiple projectors in a digital daisy chain. These cutting-edge functions produce a beautiful high-resolution image, including a 4K high-resolution display using 4 projectors and various picture-in-picture and picture-by-picture configurations.

## Screen Splitter

NEC is committed to bringing the latest and greatest Innovations to projectors. Multi-display capabilities and TileMatrix technologies are integrated into these projectors by using the HDBaseT repeater function (IN/OUT). This processing is all done internally and therefore eliminates the additional hardware typically required to produce a beautiful 4K resolution image.

### Screen Splitter (Multi-display) by Daisy Chain

Using four WUXGA projectors to project videos with a resolution of 4K (3,840 x 2,160 pixels) [TILING]  
On-screen menu operations

- 1 Use four projectors to display four similar videos.
- 2 Operate the on-screen menu using the four respective projectors to divide the image into four portions.
- 3 Adjust the lens shift of each projector to fine-tune the boundaries of the screen.

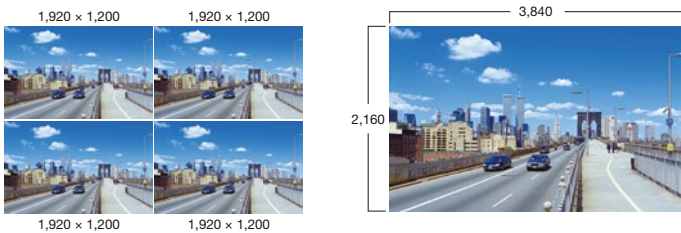

## Optional Lens specifications

| Model                                     | NP44ML*                      | NP11FL                      | NP30ZL                    | NP12ZL                    | NP13ZL                    | NP14ZL                    | NP40ZL                    | NP41ZL                    | NP43ZL                    |
|---|------------------------------|-----------------------------|---------------------------|---------------------------|---------------------------|---------------------------|---------------------------|---------------------------|---------------------------|
| Lens Type                                 | Fixed Ultra Short Throw Lens | Fixed Short Throw Lens      | Zoom Lens (Short Throw)   | Zoom Lens                 | Zoom Lens                 | Zoom Lens                 | Zoom Lens                 | Zoom Lens                 | Zoom Lens                 |
| Zoom / Focus                              | Motorised (Focus)            | Manual (Focus)              | Manual                    | Manual                    | Manual                    | Manual                    | Motorised                 | Motorised                 | Motorised                 |
| F# (Wide - Tele)                          | 2.0                          | 2.3                         | 1.9-2.1                   | 2.2-2.7                   | 1.7-2.4                   | 2.2-2.6                   | 2.0-2.5                   | 1.7-2.0                   | 2.2-2.6                   |
| f (mm)                                    | 6.27                         | 13.2                        | 13.2-17.2                 | 19.4-25.3                 | 24.4-48.6                 | 48.5-77.6                 | 13.3-18.6                 | 21.8-49.7                 | 49.7-99.8                 |
| Throw ratio (WUXGA @ 100 inch)            | 0.32:1                       | 0.79:1                      | 0.79-1.04:1               | 1.16-1.52:1               | 1.46-2.95:1               | 2.90-4.68:1               | 0.79-1.11:1               | 1.30-3.02:1               | 2.99-5.93:1               |
| Zoom Ratio                                | —                            | —                           | 1.3                       | 1.3                       | 2.0                       | 1.6                       | 1.4                       | 2.3                       | 2.0                       |
| Screen Size (Performance guarantee range) | 80-400 inch (100-350 inch)   | 40-160 inch** (60-150 inch) | 50-500 inch (60-180 inch) | 30-500 inch (40-200 inch) | 30-500 inch (40-200 inch) | 60-500 inch (60-200 inch) | 50-500 inch (80-200 inch) | 50-500 inch (80-200 inch) | 50-500 inch (80-200 inch) |
| Weight                                    | 3.1 kg                       | 1.2 kg                      | 1.14 kg                   | 1.2 kg                    | 0.84 kg                   | 1.0 kg                    | 1.6 kg                    | 1.8 kg                    | 1.8 kg                    |

\* After installing the lens unit NP44ML on the projector, be sure to secure it to the projector using the support kit (NP01LK) sold separately.  
\* The lens unit NP44ML does not support LENS CALIBRATION, LENS SHIFT and LENS MEMORY. \*\* WUXGA and WXGA models: 40-150 inch

## Edge Blending

This function seamlessly blends multiple projected images to display a single high-resolution image.



## New Optional Lenses with Peripheral Motorised Focus Features and Advanced Dust-proof Construction

Nine types of optional lenses are available along with the new NP40ZL, NP41ZL and NP43ZL as dust proof lenses with motorised zoom/focus and with a memory function. A selection of wide zoom lenses with wide vertical and horizontal lens shift and control code emulation are available, guaranteeing hassle-free installation and replacement of existing projectors. The new ultra short throw lens of NP44ML can eliminate space challenges with shorter projection distances. (100" at only 0.7 m distance) The NP40ZL, NP41ZL and NP44ML are also equipped with peripheral motorised focus, and focus adjustment is possible in two stages by the centre and the periphery, which offers excellent image quality.

\* After installing the NP44ML on the projector, be sure to secure it to the projector using the support kit (NP01LK) sold separately.

## Tilt-free and Portrait Installation Support

The projector can be rotated freely (360°) to point up or down depending on the installation requirements and can be rotated and installed on its side to create a portrait image.

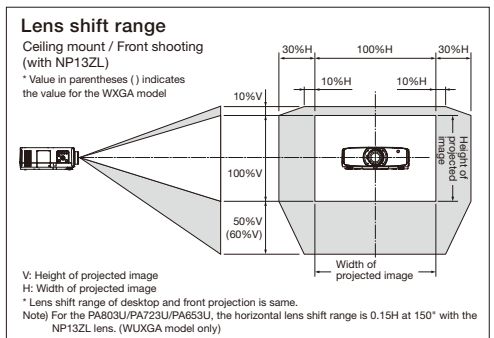
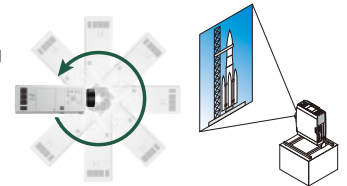

## Other Useful Functions and Features

- Cornerstone
- Geometric correction to project an image on more non-standard surfaces
- Stacking correction to boost image brightness
- Centre lens design for easy setup
- Lens memory
- Carbon meter to check the amount of reduction of CO<sub>2</sub> in eco mode
- Seamless switch function for smoother screen changes when switching the signal
- Network control
  - NaViSet Administrator 2
  - PC control
  - Alert mail
  - CRESTRON ROOMVIEW
  - AMX BEACON
  - PJLink
  - HTTP server (projector adjustment)
- Wall colour correction
- PIN security / control panel lock / security bar / security slot
- DICOM simulation



**PA803U**  
8,000 lumens WUXGA 10.2kg

**PA723U**  
7,200 lumens WUXGA 10.2kg

**PA653U**  
6,500 lumens WUXGA 10.2kg

**PA853W**  
8,500 lumens WXGA 10.2kg

**PA703W**  
7,000 lumens WXGA 10.2kg

**PA903X**  
9,000 lumens XGA 10.2kg

Brightness of each model using with NP13ZL or NP41ZL. Weight of each model does not include lens.

## Specifications

| Model  | NP-PA803U  | NP-PA723U   | NP-PA653U           | NP-PA853W                 | NP-PA703W                                  | NP-PA903X                                |                     |
|--|--|---|---------------------|---------------------------|--|--|---------------------|
| Method   | Three primary colour liquid crystal shutter projection   |   |                     |                           |  |  |                     |
| Specifications of main parts   |  |   |                     |                           |  |  |                     |
| Liquid crystal panel   | Size   | 0.76" (with DMLA) × 3 (aspect ratio: 16:10)   |                     |                           | 0.76" (with MLA) × 3 (aspect ratio: 16:10) | 0.76" (with MLA) × 3 (aspect ratio: 4:3) |                     |
|  | Pixels*1   | 2,304,000 (1,920 dots × 1,200 lines)  |                     |                           | 1,024,000 (1,280 dots × 800 lines)         | 786,432 (1,024 dots × 768 lines)         |                     |
| Projection lenses*2  | Zoom   | Motorised*3 / Manual*4 (zoom range depends on lens)   |                     |                           |  |  |                     |
|  | Focus  | Motorised*3 / Manual*4  |                     |                           |  |  |                     |
|  | Lens shifting  | Refer to Lens Specifications  |                     |                           |  |  |                     |
| Lamp wattage*5   | 420 W AC   | 400 W AC  | 370 W AC            | 420 W AC                  | 370 W AC                                   | 420 W AC                                 |                     |
| Light source (Lamp) life*6   | ECO mode OFF   | 3,000 H   | 3,500 H             | 4,000 H                   | 3,000 H                                    | 4,000 H                                  | 3,000 H             |
|  | ECO mode   | 5,000 H   | 5,000 H             | 5,000 H                   | 5,000 H                                    | 5,000 H                                  | 5,000 H             |
| Light output*7 *8 *9   | ECO mode OFF   | 8,000 lumens  | 7,200 lumens        | 6,500 lumens              | 8,500 lumens                               | 7,000 lumens                             | 9,000 lumens        |
|  | ECO mode   | 4,800 lumens  | 4,800 lumens        | 4,800 lumens              | 5,100 lumens                               | 5,100 lumens                             | 5,400 lumens        |
| Contrast ratio*8 (all white / all black)   | 10k: 1 with Iris Lamp Adj  | 8k: 1 with Iris Lamp Adj  |                     | 10k: 1 with Iris Lamp Adj | 8k: 1 with Iris Lamp Adj                   | 10k: 1 with Iris Lamp Adj                |                     |
| Screen size (throw distance)   | 30" to 500" (throw distance depends on lens)   |   |                     |                           |  |  |                     |
| Colour reproducibility   |  |   |                     |                           |  |  |                     |
| 10-bit colour processing (approx. 1.07 billion colours)                                    |  |   |                     |                           |  |  |                     |
| Scan rate  | Horizontal   | Analogue: 15 kHz, 24 to 100 kHz (24 kHz or greater for RGB inputs), conforms to VESA standards / Digital: 15 kHz, 24 to 153 kHz, conforms to VESA standards   |                     |                           |  |  |                     |
|  | Vertical   | Analogue: 48 Hz, 50 to 85 Hz, 100, 120 Hz conforms to VESA standards / Digital: 24, 25, 30, 48 Hz, 50 to 85 Hz, 100, 120 Hz conforms to VESA standards  |                     |                           |  |  |                     |
| Maximum resolution (horizontal × vertical)   | Analogue: 1,920 × 1,200 (with Advanced AccuBlend) / Digital: 4,096 × 2,160 (with Advanced AccuBlend)       |   |                     |                           |  |  |                     |
| Keystone Correction  | Horizontal   | Manual, Approx. ± 40 Max degrees  |                     |                           |  |  |                     |
|  | Vertical   | Manual, Approx. ± 40 Max degrees  |                     |                           |  |  |                     |
| Input / output connectors  |  |   |                     |                           |  |  |                     |
| Computer / Component   | Video input  | Mini D-Sub 15-pin × 1   |                     |                           |  |  |                     |
|  | Audio input  | Stereo mini jack × 1  |                     |                           |  |  |                     |
|  | Audio output   | Stereo mini jack × 1 (common for all signals)   |                     |                           |  |  |                     |
| HDMI   | Video input  | Type A HDMI connector × 2, Deep Colour (colour depth): Support 8bits, 10bits, 12bits, Colourimetry Support: RGB, YCbCr444, YCbCr422, YCbCr420, Rec.2020, Rec.709, Rec.601, Support 4K, 3D, HDCP*10, LipSync, HDR    |                     |                           |  |  |                     |
|  | Audio input  | Yes   |                     |                           |  |  |                     |
| HDBaseT / Ethernet Port  | Video input  | RJ45 × 1, Support 100BASE-TX, Deep Colour (colour depth): Support 8bits, 10bits, 12bits, Colourimetry Support: RGB, YCbCr444, YCbCr422, YCbCr420, Rec.2020, Rec.709, Rec.601, Support 4K, 3D, HDCP*10, LipSync, HDR |                     |                           |  |  |                     |
|  | Audio input  | Yes   |                     |                           |  |  |                     |
|  | Video output   | RJ45 × 1, Support 100BASE-TX, Deep Colour (colour depth): Support 8bits, 10bits, 12bits, Colourimetry Support: RGB, YCbCr444, YCbCr422, YCbCr420, Rec.2020, Rec.709, Rec.601, Support 4K, 3D, HDCP*10, LipSync      |                     |                           |  |  |                     |
|  | Audio output   | Yes   |                     |                           |  |  |                     |
| DisplayPort  | Video input  | DisplayPort 20 pin connector × 1, Deep Colour (colour depth): Support 8bits, 10bits, 12bits, Colourimetry Support: RGB, YCbCr444, YCbCr422, Rec.709, Rec.601, Support 4K, 3D, HDCP*10                               |                     |                           |  |  |                     |
|  | Audio input  | Yes   |                     |                           |  |  |                     |
| PC control connector   | D-Sub 9-pin × 1  |   |                     |                           |  |  |                     |
| USB port   | USB type A × 1, (USB 2.0 High speed / Full speed / Low speed) for Mouse                                    |   |                     |                           |  |  |                     |
| Ethernet / LAN / HDBaseT port  | RJ-45 × 1, Supports 10BASE-T / 100BASE-TX, HDBaseT   |   |                     |                           |  |  |                     |
| Remote connector   | Stereo mini jack × 1   |   |                     |                           |  |  |                     |
| 3D SYNC output terminal  | 5 V / 10 mA, synchronized signal output for 3D use   |   |                     |                           |  |  |                     |
| Usage environment  |  |   |                     |                           |  |  |                     |
| Operating temperature: 5 to 40°C*11, Operating humidity: 20 to 80 % (with no condensation) |  |   |                     |                           |  |  |                     |
| Storage temperature: -10 to 50°C, Storage humidity: 20 to 80 % (with no condensation)      |  |   |                     |                           |  |  |                     |
| Operating altitude: 0 to 3,650 m (1,700 to 3,650 m: Set [FAN MODE] to [HIGH ALITUDE])      |  |   |                     |                           |  |  |                     |
| Power supply   |  |   |                     |                           |  |  |                     |
| 100 - 240 V AC, 50/60 Hz   |  |   |                     |                           |  |  |                     |
| Power consumption  | ECO mode   | 566 W (100 - 130 V)   | 542 W (100 - 130 V) | 506 W (100 - 130 V)       | 566 W (100 - 130 V)                        | 506 W (100 - 130 V)                      | 566 W (100 - 130 V) |
|  | OFF  | 542 W (200 - 240 V)   | 518 W (200 - 240 V) | 482 W (200 - 240 V)       | 542 W (200 - 240 V)                        | 482 W (200 - 240 V)                      | 542 W (200 - 240 V) |
|  | ECO mode   | 390 W (100 - 130 V) / 376 W (200 - 240 V)   |                     |                           |  |  |                     |
|  | STANDBY (Link-up)  | 0.15 W (100 - 130 V) / 0.21 W (200 - 240 V)   |                     |                           |  |  |                     |
| STANDBY (Link-down)*12   | 0.11 W (100 - 130 V) / 0.16 W (200 - 240 V)  |   |                     |                           |  |  |                     |
| Rated input current  | 6.2 A - 2.6 A  | 6.0 A - 2.5 A   | 5.6 A - 2.3 A       | 6.2 A - 2.6 A             | 5.6 A - 2.3 A                              | 6.2 A - 2.6 A                            |                     |
| Dimensions (W × H × D)   | 499 × 164 × 406 mm (Net dimensions, not including protruding parts), 591 × 259 × 491 mm (Gross dimensions) |   |                     |                           |  |  |                     |
| Weight   | 10.2 kg (not including lens), 12.5 kg (Gross weight)   |   |                     |                           |  |  |                     |

\*1: Effective pixels are more than 99.99%. \*2: Refer to Lens Specifications. \*3: When attached with NP40ZL, NP41ZL, NP43ZL, NP44ML. \*4: When attached with NP30ZL, NP11FL, NP12ZL, NP13ZL, NP14ZL. \*5: Wattage when ECO mode is OFF. \*6: Time at which the light source is at half brightness; not a guarantee time. \*7: This is the light output value (lumens) when the [PRESET] mode is set to [HIGH-BRIGHT]. If any other mode is selected as the [PRESET] mode, the light output value may drop slightly. \*8: Compliance with ISO21118-2012. \*9: When attached with NP13ZL or NP41ZL and Eco mode OFF. \*10: If you are unable to view material via the HDMI DisplayPort and HDBaseT input, this does not necessarily mean the projector is not functioning properly. With the implementation of HDCP there may be cases in which certain content is protected with HDCP and might not be displayed due to the decision/intention of the HDCP community. (Digital Content Protection, LLC). HDMI: Supports HDCP2.1/4. DisplayPort: Supports HDCP1.4, HDBaseT: Supports HDCP2.1/4. \*11: 35 to 40°C - "Forced ECO mode" \*12: Internal measured value. All wired network ports are connected and active. • These specifications and the product's design are subject to change without notice.

## Throwing distance and Screen size

### NP-PA803U / NP-PA723U / NP-PA653U (WUXGA) Unit: m

| Screen Size (W × H) | Lens unit model name |        |          |           |           |           |          |           |
|---------------------|----------------------|--------|----------|-----------|-----------|-----------|----------|-----------|
|                     | NP44ML               | NP11FL | NP12ZL   | NP13ZL    | NP14ZL    | NP40ZL    | NP41ZL   | NP43ZL    |
| 30" (0.65x0.40)     | -                    | -      | 0.7-0.9  | 0.9-1.9   | -         | -         | -        | -         |
| 40" (0.86x0.54)     | -                    | 0.7    | -        | 1.0-1.3   | 1.2-2.5   | -         | -        | -         |
| 60" (1.29x0.80)     | -                    | 1.0    | 1.0-1.3  | 1.5-1.9   | 1.9-3.8   | 3.7-6.0   | 1.0-1.4  | 1.7-3.9   |
| 80" (1.72x1.08)     | -                    | 1.4    | 1.4-1.8  | 2.0-2.6   | 2.5-5.1   | 5.0-8.0   | 1.4-1.9  | 2.2-5.2   |
| 100" (2.15x1.35)    | 0.70                 | 1.7    | 1.7-2.2  | 2.5-3.3   | 3.2-6.3   | 6.3-10.1  | 1.7-2.4  | 2.8-6.5   |
| 120" (2.59x1.62)    | 0.84                 | 2.1    | 2.0-2.7  | 3.0-3.9   | 3.8-7.6   | 7.5-12.1  | 2.0-2.9  | 3.4-7.8   |
| 150" (3.23x2.02)    | 1.06                 | 2.6    | 2.6-3.4  | 3.8-4.9   | 4.8-9.5   | 9.4-15.2  | 2.6-3.6  | 4.2-9.8   |
| 200" (4.31x2.69)    | 1.43                 | -      | 3.4-4.5  | 5.1-6.6   | 6.4-12.7  | 12.6-20.3 | 3.4-4.8  | 5.7-13.0  |
| 240" (5.17x3.23)    | 1.72                 | -      | 4.1-5.4  | 6.1-7.9   | 7.6-15.2  | 15.2-24.4 | 4.1-5.8  | 6.8-15.6  |
| 300" (6.46x4.04)    | 2.16                 | -      | 5.2-6.8  | 7.6-9.9   | 9.6-19.1  | 19.0-30.5 | 5.2-7.3  | 8.5-19.6  |
| 400" (8.62x5.39)    | 2.89                 | -      | 6.9-9.0  | 10.2-13.2 | 12.8-25.5 | 25.4-40.7 | 6.9-9.7  | 11.4-26.1 |
| 500" (10.77x6.73)   | -                    | -      | 8.7-11.3 | 12.7-16.5 | 16.0-31.9 | 31.8-50.9 | 8.6-12.1 | 14.2-32.6 |

### NP-PA853W / NP-PA703W (WXGA) Unit: m

| Screen Size (W × H) | Lens unit model name |        |          |           |           |           |          |           |
|---------------------|----------------------|--------|----------|-----------|-----------|-----------|----------|-----------|
|                     | NP44ML               | NP11FL | NP12ZL   | NP13ZL    | NP14ZL    | NP40ZL    | NP41ZL   | NP43ZL    |
| 30" (0.65x0.40)     | -                    | -      | 0.7-1.0  | 0.9-1.9   | -         | -         | -        | -         |
| 40" (0.86x0.54)     | -                    | 0.7    | -        | 1.0-1.3   | 1.2-2.5   | -         | -        | -         |
| 60" (1.29x0.80)     | -                    | 1.0    | 1.0-1.3  | 1.5-2.0   | 1.9-3.8   | 3.7-6.0   | 1.0-1.4  | 1.7-3.9   |
| 80" (1.72x1.08)     | -                    | 1.4    | 1.4-1.8  | 2.0-2.6   | 2.5-5.1   | 5.0-8.0   | 1.4-1.9  | 2.2-5.2   |
| 100" (2.15x1.35)    | 0.70                 | 1.7    | 1.7-2.2  | 2.5-3.3   | 3.2-6.4   | 6.3-10.1  | 1.7-2.4  | 2.8-6.5   |
| 120" (2.59x1.62)    | 0.85                 | 2.1    | 2.0-2.7  | 3.0-4.0   | 3.8-7.7   | 7.6-12.2  | 2.1-2.9  | 3.4-7.8   |
| 150" (3.23x2.02)    | 1.07                 | 2.6    | 2.6-3.4  | 3.8-5.0   | 4.8-9.6   | 9.5-15.3  | 2.6-3.6  | 4.3-9.8   |
| 200" (4.31x2.69)    | 1.43                 | -      | 3.4-4.5  | 5.1-6.6   | 6.4-12.8  | 12.7-20.4 | 3.4-4.9  | 5.7-13.1  |
| 240" (5.17x3.23)    | 1.73                 | -      | 4.1-5.4  | 6.1-8.0   | 7.7-15.4  | 15.3-24.5 | 4.1-5.8  | 6.8-15.7  |
| 300" (6.46x4.04)    | 2.17                 | -      | 5.2-6.8  | 7.7-10.0  | 9.6-19.2  | 19.1-30.7 | 5.2-7.3  | 8.6-19.6  |
| 400" (8.62x5.39)    | 2.90                 | -      | 6.9-9.0  | 10.2-13.2 | 12.8-25.7 | 25.5-40.9 | 6.9-9.7  | 11.4-26.2 |
| 500" (10.77x6.73)   | -                    | -      | 8.7-11.3 | 12.8-16.7 | 16.1-32.1 | 31.9-51.2 | 8.7-12.2 | 14.3-32.8 |

### NP-PA903X (XGA) Unit: m

| Screen Size (W × H) | Lens unit model name |        |          |           |           |           |          |           |
|---------------------|----------------------|--------|----------|-----------|-----------|-----------|----------|-----------|
|                     | NP44ML               | NP11FL | NP12ZL   | NP13ZL    | NP14ZL    | NP40ZL    | NP41ZL   | NP43ZL    |
| 30" (0.61x0.46)     | -                    | -      | 0.7-0.9  | 0.9-1.8   | -         | -         | -        | -         |
| 40" (0.81x0.61)     | -                    | 0.6    | -        | 0.9-1.2   | 1.2-2.4   | -         | -        | -         |
| 60" (1.22x0.91)     | -                    | 1.0    | 1.0-1.3  | 1.4-1.9   | 1.8-3.7   | 3.6-5.8   | 1.0-1.4  | 1.6-3.7   |
| 80" (1.63x1.22)     | -                    | 1.3    | 1.3-1.7  | 1.9-2.5   | 2.4-4.9   | 4.8-7.8   | 1.3-1.8  | 2.2-5.0   |
| 100" (2.03x1.52)    | -                    | 1.6    | 1.6-2.1  | 2.4-3.2   | 3.0-6.1   | 6.0-9.7   | 1.6-2.3  | 2.7-6.3   |
| 120" (2.44x1.83)    | 0.81                 | 2.0    | 2.0-2.6  | 2.9-3.8   | 3.7-7.4   | 7.3-11.7  | 2.0-2.8  | 3.3-7.5   |
| 150" (3.05x2.29)    | 1.02                 | 2.5    | 2.5-3.2  | 3.7-4.8   | 4.6-9.2   | 9.1-14.7  | 2.5-3.5  | 4.1-9.4   |
| 200" (4.06x3.05)    | 1.38                 | -      | 3.3-4.3  | 4.9-6.4   | 6.1-12.3  | 12.2-19.6 | 3.3-4.7  | 5.5-12.5  |
| 240" (4.88x3.66)    | 1.66                 | -      | 4.0-5.2  | 5.9-7.7   | 7.4-14.8  | 14.7-23.6 | 4.0-5.6  | 6.6-15.1  |
| 300" (6.10x4.57)    | 2.08                 | -      | 5.0-6.5  | 7.4-9.6   | 9.2-18.5  | 18.4-29.5 | 5.0-7.0  | 8.2-18.8  |
| 400" (8.13x6.10)    | 2.78                 | -      | 6.7-8.7  | 9.8-12.8  | 12.3-24.7 | 24.5-39.3 | 6.7-9.4  | 11.0-25.1 |
| 500" (10.16x7.62)   | -                    | -      | 8.4-10.9 | 12.3-16.0 | 15.4-30.9 | 30.7-49.2 | 8.3-11.7 | 13.7-31.4 |

\* Stated projection distances are standard values from lens or mirror surface to screen centre. \* For a stack installation, the recommended projection distances will be different. \* The values in the table are design values and may vary. \* After installing the lens unit NP44ML on the projector, be sure to secure it to the projector using the support kit (NP01LK) sold separately.



- Do not stare into the lens during use.
- The projector can be unplugged immediately after it is turned off. Parts of the projector become heated during operation. Use caution when picking up the projector immediately after it has been operating.

MultiPresenter, NaViSet, CARBON METER, SweetVision, TLEMATRIX and GEOMETRIC CORRECTION are trademarks or registered trademarks of NEC Display Solutions, Ltd. in Japan and other countries. The terms HDMI and HDMI High-Definition Multimedia Interface, and the HDMI Logo are trademarks or registered trademarks of HDMI Licensing Administrator, Inc. in the United States and other countries. HDBaseT and HDBaseT Alliance logo are trademarks of HDBaseT Alliance.

DisplayPort Compliance Logo is a trademark of Video Electronics Standards Association in the United States and other countries. CRESTRON and CRESTRON ROOMVIEW are trademarks or registered trademarks of Crestron Electronics, Inc. in the United States and other countries. Windows is a registered trademark or trademark of Microsoft Corporation in the United States and / or other countries.

Trademark P.Link is a trademark applied for trademark right in Japan, the United States of America and other countries and areas. Blu-ray is a trademark of the Blu-ray Disc Association. AMX is a trademark or registered trademark of AMX LLC in the United States and other countries.

All other brand or product names are trademarks or registered trademarks of their respective holders. The images in this brochure are samples.

All specifications are subject to change without notice. June 2019

©2018 NEC Display Solutions, Ltd.

NEC Display Solutions, Ltd.

4-28, Mita 1-chome, Minato-ku, Tokyo 108-0073, Japan

<https://www.nec-display.com/ap/>



## Remote control



(included accessory)

## Options



Replacement lamp  
NP42LP

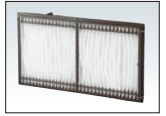

Replacement filter  
NP06FT

Cable Cover  
NP10CV



MultiPresenter Stick  
DS1-MP10RX\*

\* Make sure to choose the appropriate MultiPresenter Stick for the usage country or area by visiting our website. ([https://www.nec-display.com/ap/en\\_display/mp10rx/index.html](https://www.nec-display.com/ap/en_display/mp10rx/index.html))

Lenses  
NP11FL NP30ZL NP12ZL  
NP13ZL NP14ZL NP40ZL  
NP41ZL NP43ZL NP44ML

Lens support kit  
NP01LK

## Cabinet dimensions

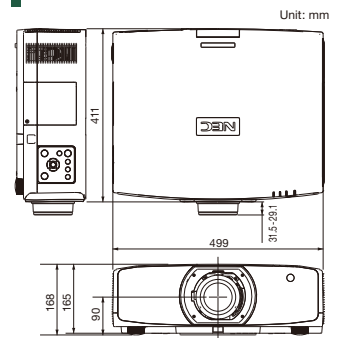

Unit: mm

168

165

90

90

90

90

90

90

90

90

90

90

90

90

90

90

90

90

90

90

90

90

90

90

90

90

90

90

90

90

90

90

90

90

90

90

90

90

90

90

90

90

90